

Title		
Size	Number	Revision
A4		
Date:	7/7/2011	Sheet of
File:	D:\PROJECT\Bg2_e.SchDoc	Drawn By:

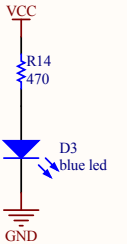
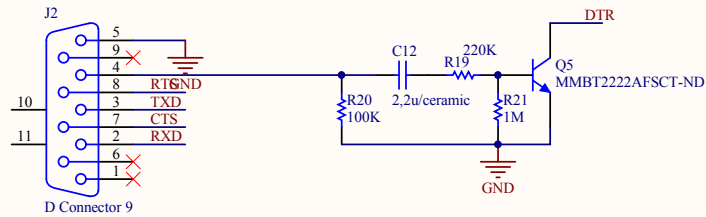
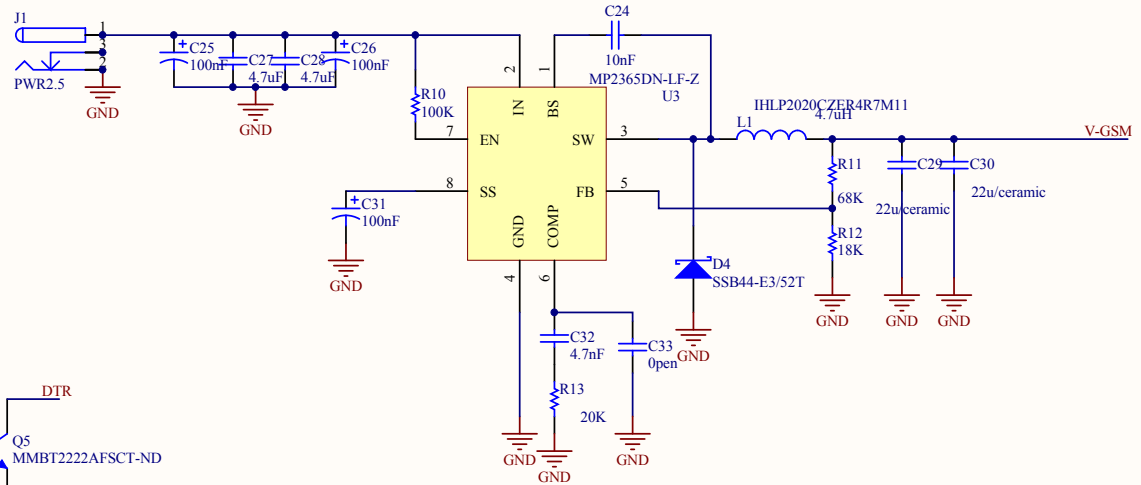
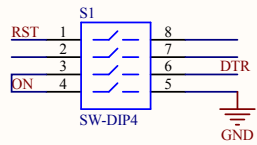
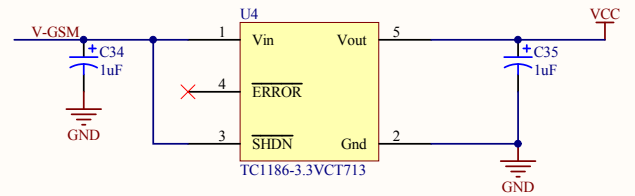
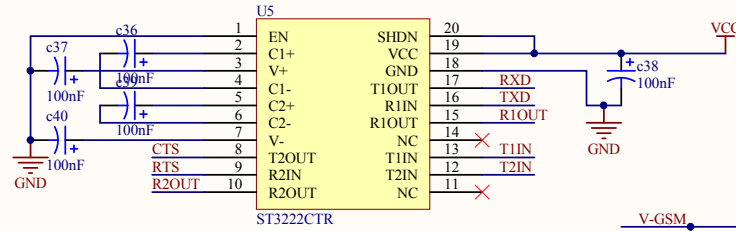
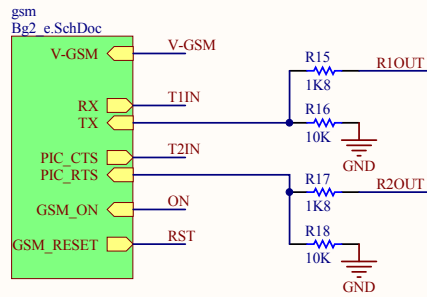

Title		
Size	Number	Revision
A4		
Date:	7/7/2011	Sheet of
File:	D:\PROJECT\MEVB.SchDoc	Drawn By: